

LED

Fischer & Honsel GmbH
Graf-Gottfried-Str. 111
D-59755 Arnsberg
+49 (0) 2932 – 989 – 0
www.fischer-honsel.de
info@fischer-honsel.de

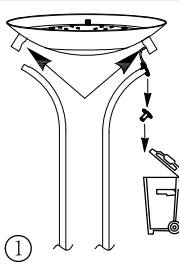

1

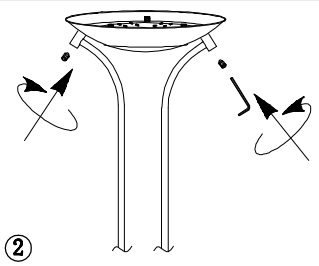

2

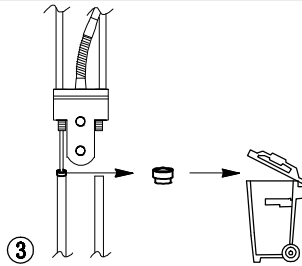

3

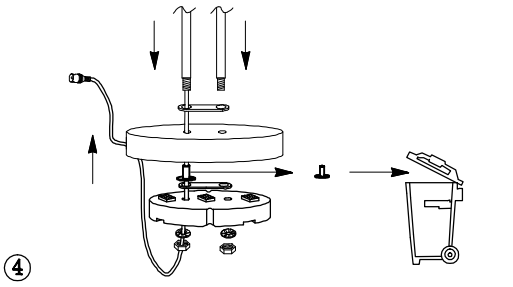

4

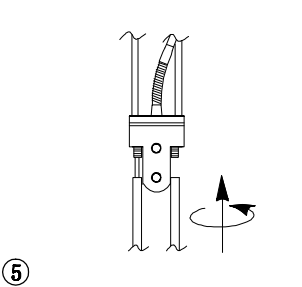

5

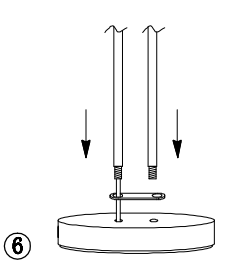

6

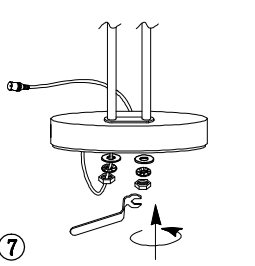

7

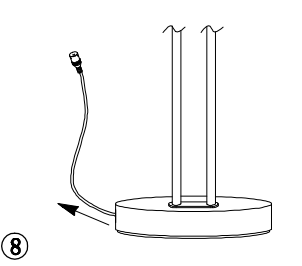

8

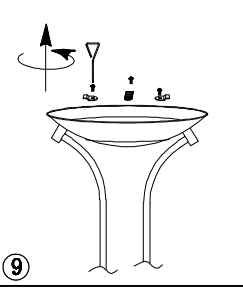

9

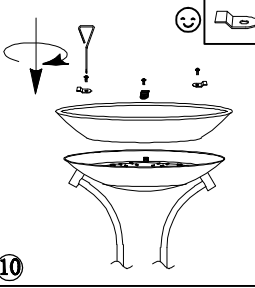

10

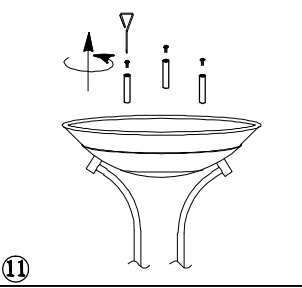

11

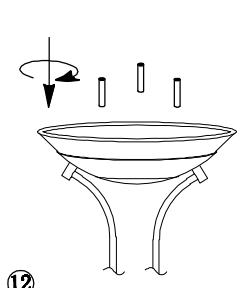

12

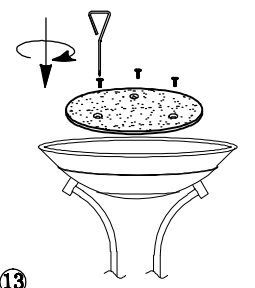

13

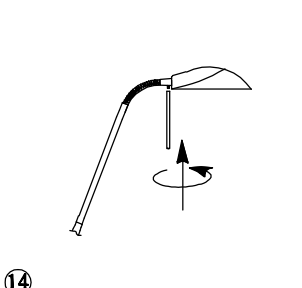

14

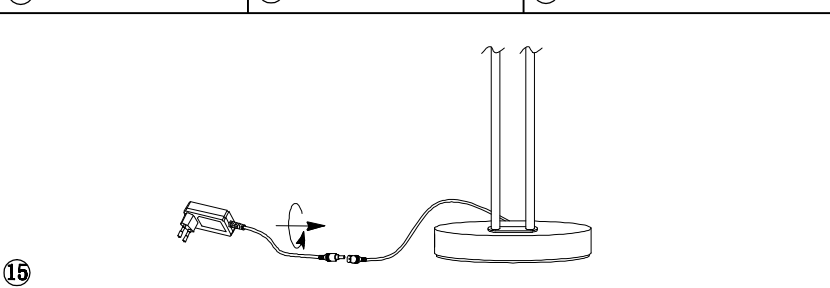

15

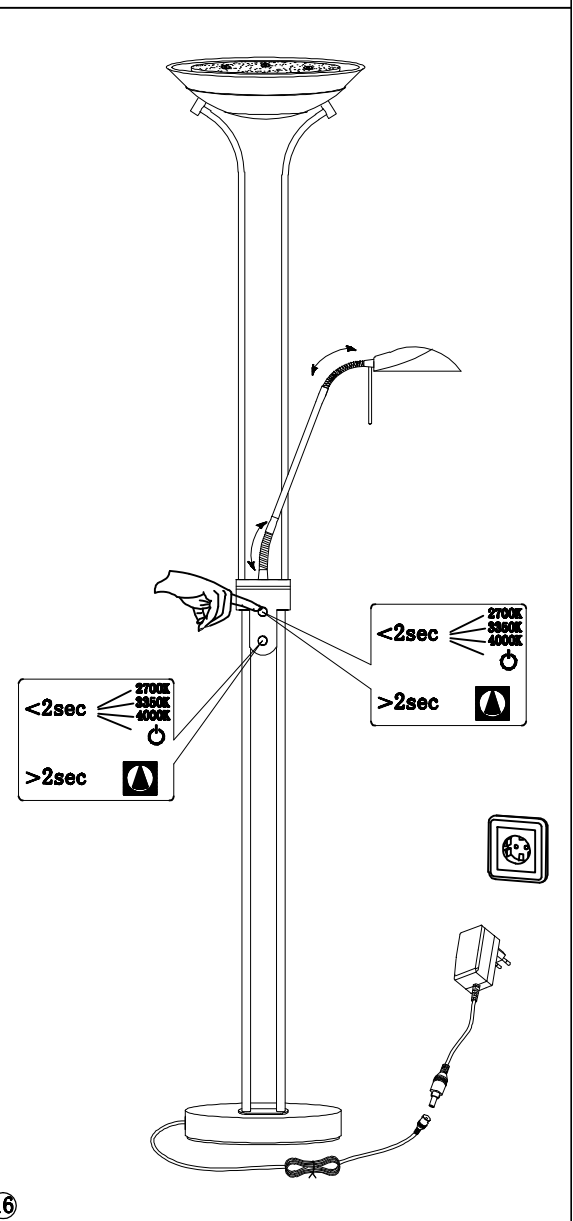
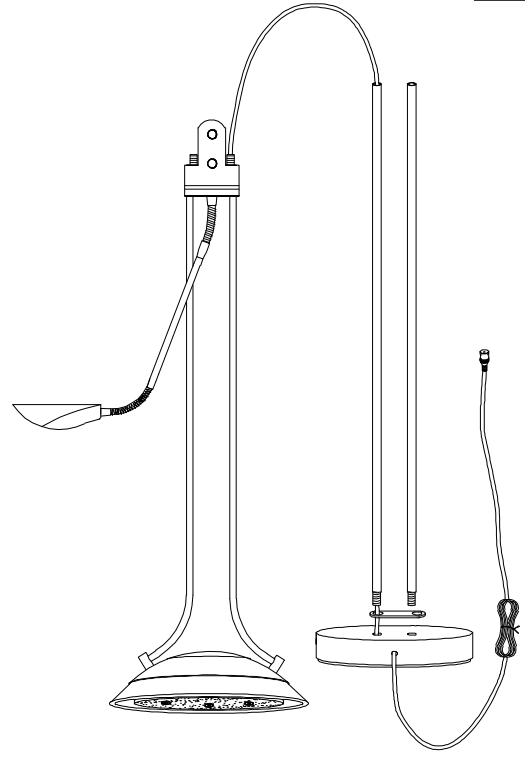

16

<2sec 2700K 3000K 4000K

>2sec

